



NMEA 2000
NMEA 0183

Table of contents

Disclaimer	3
Installation Kit	4
Before installation	5
Proper Interceptor installation in transom	5
Interceptor Installation	6
Indirect Installation	8
Spare Parts List	9
Warranty Conditions	10
Registration	11

Disclaimer

The interceptor units are also steering equipment and it is the sole responsibility of the navigator-operator to ensure that, at any point, any problem that will alter the boat's course, arising from malfunction of interceptors, should be dealt immediately by the operator. At no circumstances, fault of our interceptor equipment leading to any kind of accident, creates liability for the manufacturer.

Trademark Notice

Hydrotab is a registered trademark of Olympic Engineering Ltd, Greece. All other trademarks, trade names or company names referenced herein are used for identification only and are property of their respective owners.

Patent Notice

The Hydrotab products are protected by patents and industrial design patents, patents pending or design patents pending.

Declaration of conformity

This product conforms to the following Electromagnetic Compatibility (EMC) regulations and standards for use in marine environments.
CE EN 60945

Technical information and Documentation

The technical information provided in this document was accurate and correct at the corresponding production time of the Hydrotab interceptors. Our operating principal for improving the manufactured product, may lead to changes regarding its specifications without prior notice. Liability will not be accepted for any inaccuracy considering the product and the user manual.

Fair use statement

This manual can be printed or copied for your own use only. Copies should not be provided to third parties and manual should not be commercialized.

Product Disposal

Waste removal of this product must be according to the Waste Electrical and Electronic Equipment (WEEE) Directive.

Product Registration

Please register your product online in order the warranty to be valid.

Installation Kit

1. One Intceptor per package

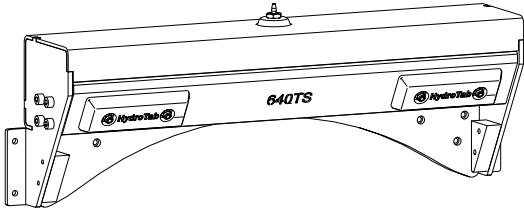

2. Interceptors' Drilling pattern

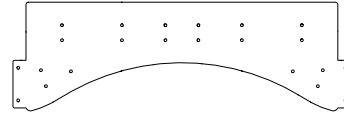

4. Fittings

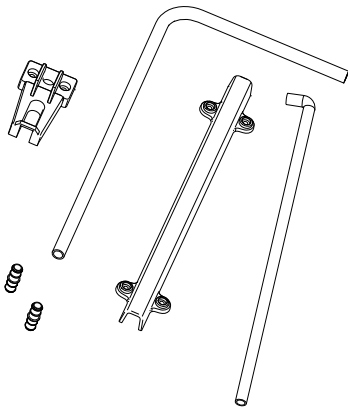

5. Screws



Interceptor mounting screws (6,3x32)



Fitting mounting screws (4,8x25)



Fitting mounting screws (4,2x18)



Washers M6

6. 7m piping

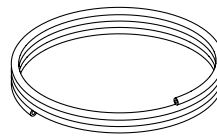

Required Tools for Installation

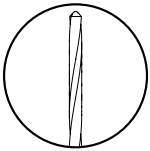

Drill Ø3

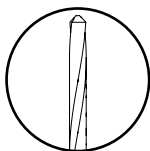

Drill Ø4

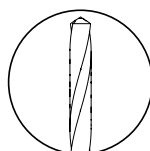

Drill Ø5,5

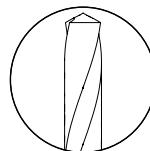

Drill Ø12

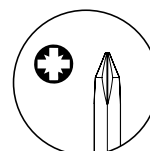

Screw driver

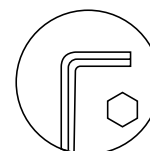

Allen Key N 05

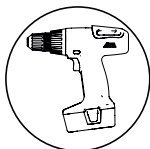

Drilling Tool



Sikaflex Gun

Before Installation

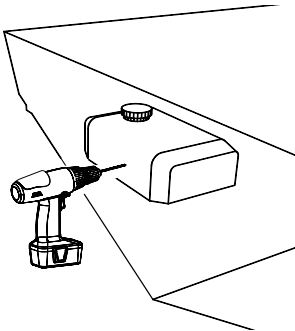

Make sure there are no obstructions behind the drilling area (tanks, fuel lines, cabling) which can be damaged or prevent the installation procedure.

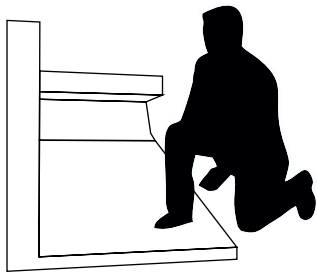

Attention! Make sure that the pipe insertion hole is accessible from the engine room.

Proper Interceptor installation in transom

Right

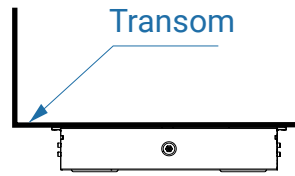

Wrong

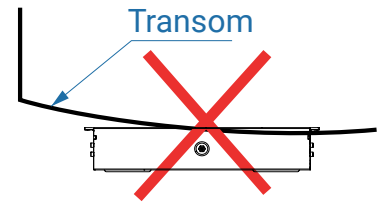

If the boat's transom has a significant curvature, it is necessary to create a flat plane for the installation. Acceptable flatness tolerances: 2mm.

For aluminum hulls, it is suggested Isolation Plates between hull and interceptors to be installed. You can find installation instructions in the Isolation Plates Kit.

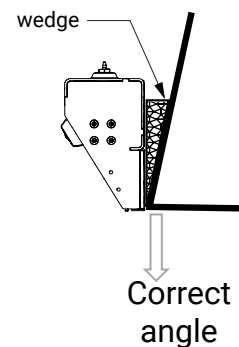
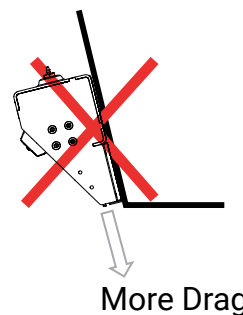
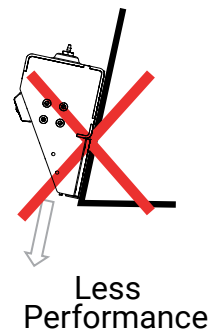
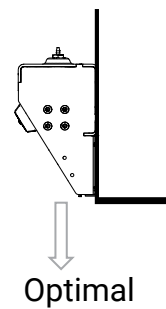

For maximum performance and less drag, install interceptors on the transom so blades deploy vertically. If transom is not vertical to water plane, correct the angle by using wedges or other means.

Attention:

The diameters of the holes in the templates are suggested for fiberglass boats. These dimensions are suitable for the supplied stainless steel screws that come with the units.

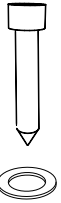

All screws must be placed with their respective washers.

The use of the 5,5 drill is suggested. The installer of the units must make sure that the 5,5 mm holes are suitable for the specific hull. The diameters of the drills that can be used are from 5,3 mm to 5,5mm (maximum) depending on the quality of the hull.

Interceptor Installation

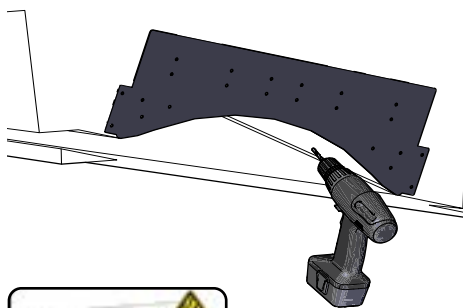

You will need

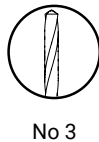

No 3

1

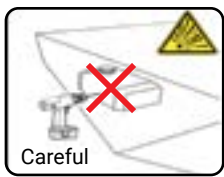

Drill all the pattern holes with 3mm bore without removing the pattern.

You will need

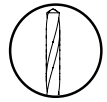
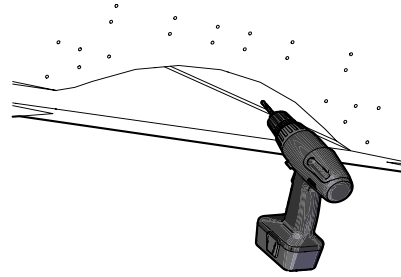

No 5,5

2

Remove the drilling pattern and drill according to the pattern instructions.

You will need

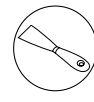
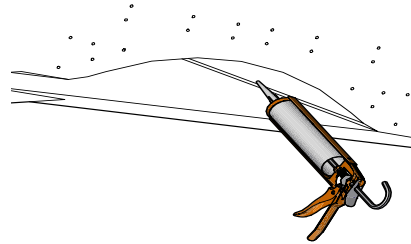

Spatula



Sikaflex

3

Apply Sikaflex 291 to the holes and use a spatula to clean the excess glue from holes.

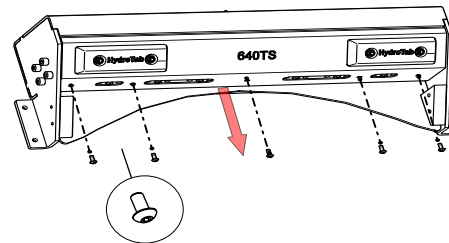

4

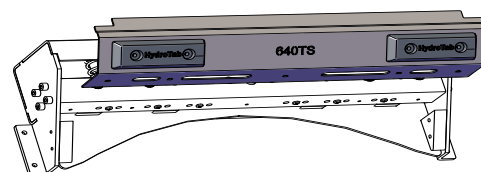

To open the cap you must ONLY remove the M5 screws.

Direct air supply

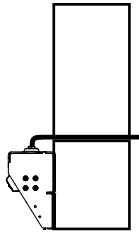

Indirect Air Supply Kit

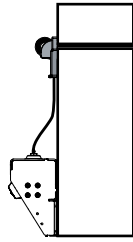

5

For Direct Air Supply: Advise the instructions.
For indirect Air Supply: Use the components included in the kit.

You will need

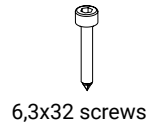
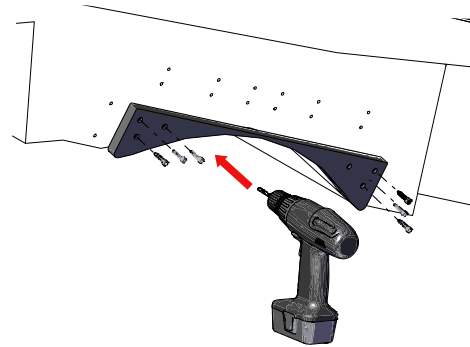

7

Mount the back PE guide to the transom.

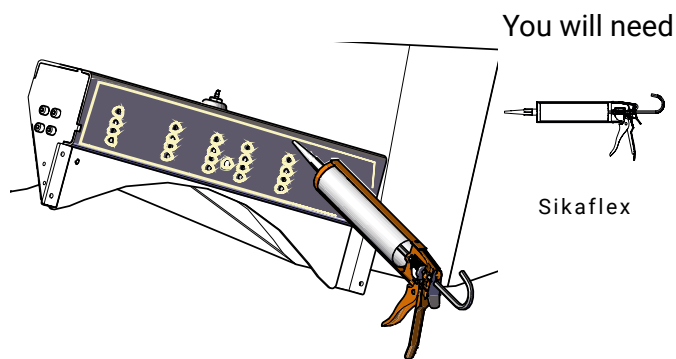

You will need

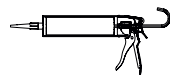

Sikaflex

6

Apply Sikaflex to the interceptor.

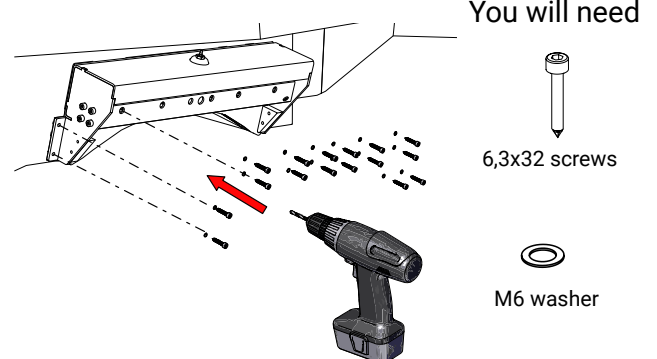

You will need

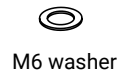
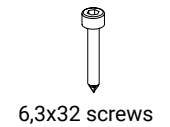

8

Mount the unit to the transom.

Attention:

All the holes must be sealed.
Sikaflex 291 is used in order to:
- seal the holes
- compensate for transom plane irregularities
- cement the unit to the hull.
The boat must remain 48 hours for drying.

Indirect Installation



Drill the transom, at the tube holder holes with a 12mm bore for the middle (tube passing through) hole and with a 3,8mm. bore for the other two (mounting) holes.



Drill the transom, at the tube cover holes with a 3mm bore.

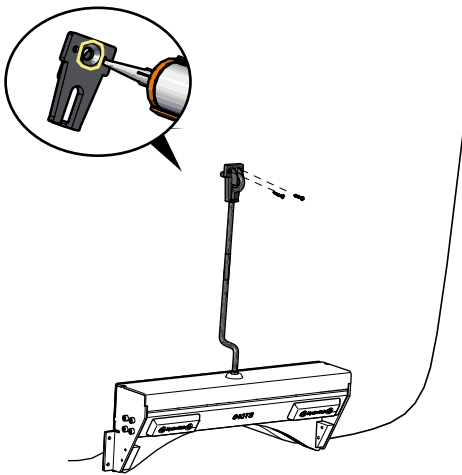

Attention:

Before mounting the tube holder, apply Sikaflex as shown in the image. Mount the tube holder to the transom and connect the interceptor with the air unit.

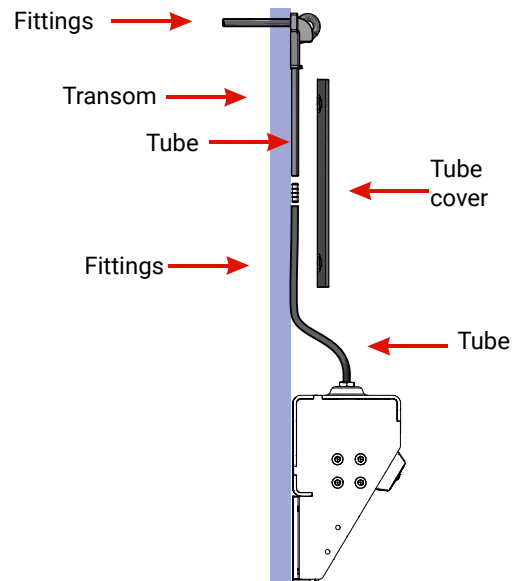

Air Supply:

Connect the interceptor with the Air Unit using the components given in the image.

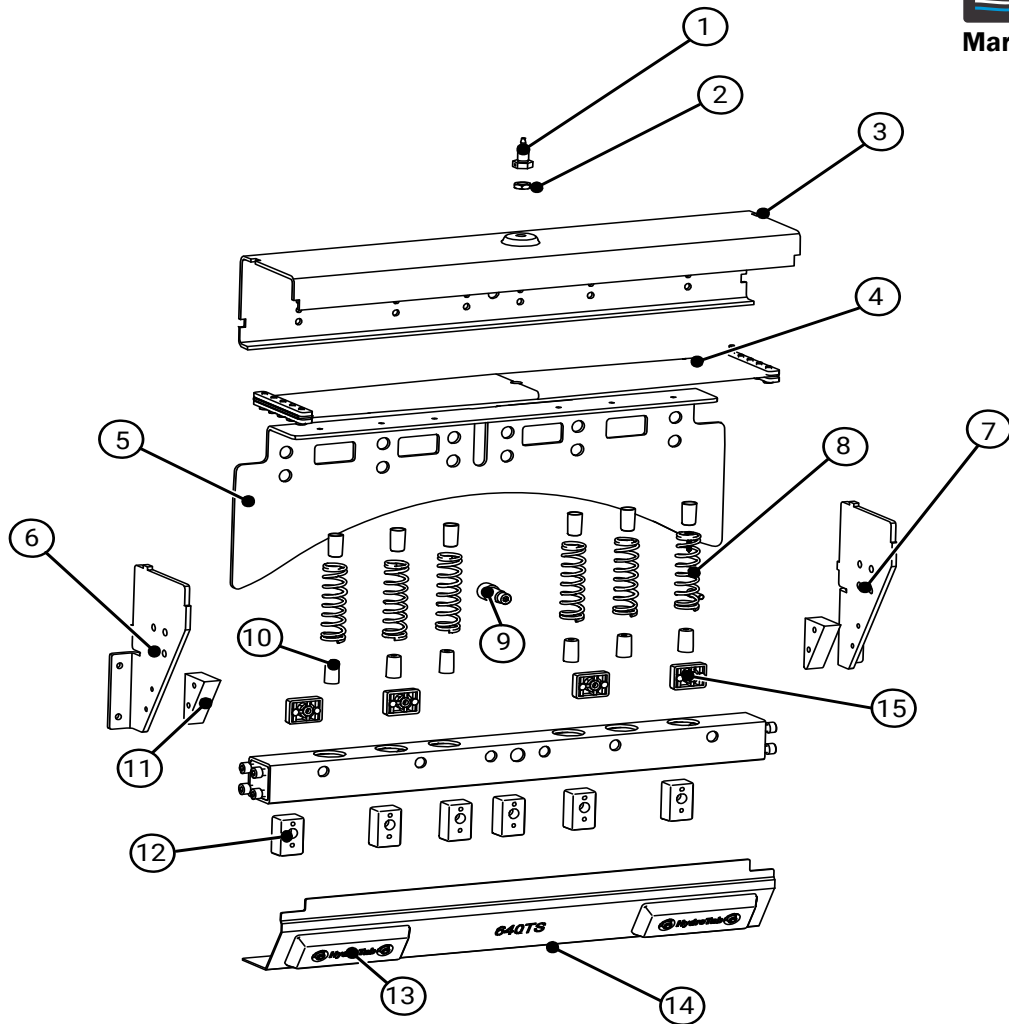

BOM ID	Part No	Description
1	REV-00605	AIR SUPPLY FITTING
2	REV-00094	FITTING NUT M12
3	LAS-00596	HYDROTAB BODY, TYPE F
4	ASM-00815	TUBULAR ASSY, 640FW, AIR, F TYPE
5		HYDROTAB 640TS BLADE,
6		640TS SIDE FLANGE, LEFT
7		640TS SIDE FLANGE, LEFT
8	SPR-00007	SPRING
9	REV-00427	FW SERIES BODY-BEAM SPACER
10	GEN-00032	HYDROTAB SPRING GUIDE
11		PE SIDE GUIDE
12	GEN-00025	HYDROTAB GUIDE 48x30x19.6
13	GEN-00540	Aluminum Anode
14	LAS-01212	HYDROTAB 640TS, FRONT COVER
15	GEN-00018	HYDROTAB GUIDE 40x30x12.1
FITTINGS (ASM-01600)		
16	GEN-00571	TUBE HOLDER
17	REV-00606	SUPPLY CONNECTION FITTING
18	GEN-00634	TUBE HOLDER
19	PNE-01405	AIR FITTING EXTENSION

Warranty Conditions

LS Series Interceptor units are covered by a 2-year Warranty. Recoil springs, electrical/electronic parts and devices come with a 2-year warranty. Anodes (consumables) are not included in the warranty. Hydrotab's warranty only covers the repair or replacement of spare parts.

System selections

It is the sole responsibility of the buyer to choose the correct system and even with Hydrotab's suggestion for a system, the overall responsibility is with the buyer.

Limited warranty

Provided that the system has been installed in accordance with the installation manual we provide, and no damage has been caused due to improper handling or practices, Hydrotab will replace any defective parts or parts that failed due to improper manufacturing within the applicable warranty period.

Hydrotab only covers the parts' replacement. Fitting or shipping costs are not covered by warranty.

Hydrotab will select if we will repair or replace any given part. Repaired or replaced products will assume the remainder of the warranty time and under no conditions will the full time of warranty be renewed.

Limited warranty periods

Limited warranty period is two years (2 years) from the product shipment from our premises.

Extended limited warranty period

It is provided in case:

- a) Hydrotab trim system is included as equipment of a newly purchased boat directly by from the boat-builder or his reseller.
- b) Hydrotab trim system has been purchased through a Hydrotab dealer.

The extended limited warranty period is valid for three (3) years from the shipping date, provided that the customer has downloaded, completed and submitted the online registration form within one month (30) days from the purchase in the following url.

<https://www.hydrotab.gr/product-registration>

In case the dealer sells separate units of Interceptors, Air Units and Controllers that constitute a full system that is not initially sold (as a complete system) by Hydrotab, the dealer has the responsibility to provide the separate Serial Numbers for the Interceptors, Air Units and Controllers and guide the end user for the proper registration of his serial numbers for the extended warranty to be valid.

The authorized dealer is responsible for the product's service.

For any services or spare parts requirements and replacements during warranty period, the original invoice is necessary to be presented.

For the replacement of any part of the system (interceptors, Air Unit, any controller etc.) under warranty, the replaced parts must be returned to Hydrotab Marine Engineering for inspection, otherwise warranty is not valid.

Cost of dismantling - assembly and spare parts transportation is borne by the user.

The warranty does not foresee, under any circumstances, replacement of the whole Hydrotab system.

What is not covered by the warranty:

Damage caused by the lack or non-replacement of worn anodes (for BT, FW, TS Series).

Damage caused by improper installation and use not consistent with the manual.

Damage with external visible deformation of the product caused by misuse of the user or other external causes.

Damage to any component caused during transportation, installation or repair from non-authorized personnel.

Conversions or modifications made after the initial sale.

N. Triantafyllis Ltd (Hydrotab Marine Engineering) is not liable for any incidental, indirect or consequential damages or losses, including, without limitation: travel expenses, transport, lifting and hauling, costs, loss of income, loss of time, loss of property, loss of profits, personal injury or damage of any products, different from those that the company distributes. Any further (except the above mentioned) commitment of the intermediate dealer regarding the sale terms or servicing of Hydrotab products does not create any liability of our company.



www.hydrotab.gr/product-registration

Congratulations for your
new Hydrotab system!

Please register to activate the
extended limited warranty

