



Moby Automatic Controller

Disclaimer

The interceptor units are also steering equipment and it is the sole responsibility of the navigator-operator to ensure that, at any point, any problem that will alter the boat's course, rising from malfunction of interceptors, should be dealt immediately by the operator. At no circumstances, fault of our interceptor equipment leading to any kind of accident, creates liability for the manufacturer.

Trademark Notice

Hydrotab is a registered trademark of Olympic Engineering Ltd, Greece. All other trademarks, trade names or company names referenced herein are used for identification only and are property of their respective owners.

Patent Notice

The Hydrotab products are protected by patents and industrial design patents, patents pending or design patents pending.

Declaration of conformity

This product conforms to the following Electromagnetic Compatibility (EMC) regulations and standards for use in marine environments.
CE EN 60945.

Technical information and Documentation

The technical information provided in this document was accurate and correct at the corresponding production time of the Hydrotab interceptors. Our operating principal for improving the manufactured product, may lead to changes regarding its specifications without prior notice. Liability will not be accepted for any inaccuracy considering the product and the user manual.

Fair use statement

This manual can be printed or copied for your own use only. Copies should not be provided to third parties and manual should not be commercialized.

Product Disposal

Waste removal of this product must be according to the Waste Electrical and Electronic Equipment (WEEE) Directive.

Product Registration

Please register your product online in order the warranty to be valid.

Table of Contents

Disclaimer.....	2
MOBY CONTROLLER OVERVIEW	4
Moby Controller Installation.....	5
Moby Menu Screens Explanation	6
Moby Menu Screens Explanation - Pitch Profile Explanation	19
Moby Menu Screens Explanation - Repeater Mode Screen Differentiation	21
Moby Menu Screens Explanation - Updating your Device Firmware	23
Moby Troubleshooting.....	24
Notes	26
Notes	27

MOBY CONTROLLER OVERVIEW

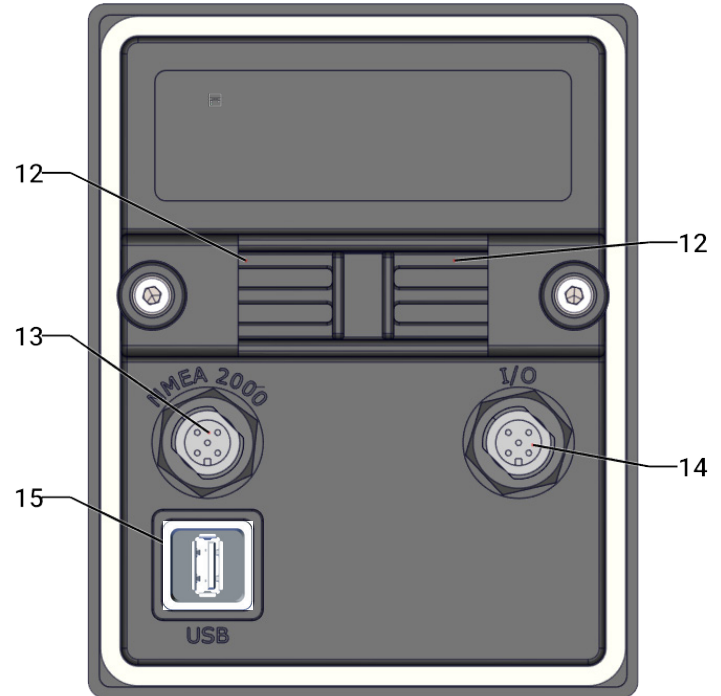
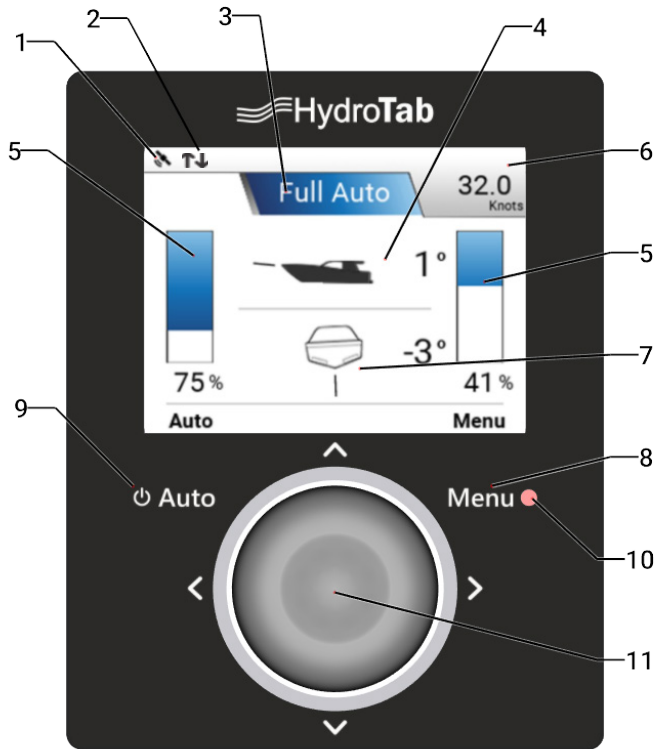

Display Icons

1	GPS Icon	Indication whether GPS signal is acquired
2	Air Unit Connection Icon	Indication of air unit connection status
3	System operation mode	1. Manual mode: manual operation of the interceptors 2. Auto pitch: interceptors position adjusted according to the current boat speed 3. Full auto: auto pitch and roll operation for optimal boat cruising behavior
4	Pich Icon	Boat plitch angle indication
5	Gauges	Interceptors position % indication
6	Speed	Current speed indication
7	Roll icon	Boat roll angle indication

Menu Navigation and function keys

8	Menu Position	1. enter system menu 2. while in system menu, press to return to home screen
9	On/Off + Auto Position	1. Hold for 4 seconds to power on/off the system 2. Press to select system operation mode. 3. While in system menu, press to return to previous screen
10	Light Sensor	Adjusts the Day/Night mode
11	Main button	Multi-functional button

Mounting and Connection

12	Sliders	Sliding parts for mounting the controller
13	NMEA 2000 Port	Connection to NMEA 2000 network
14	I/O Port	Power supply
15	USB port	USB port, used for controller firmware update

Moby Controller Installation

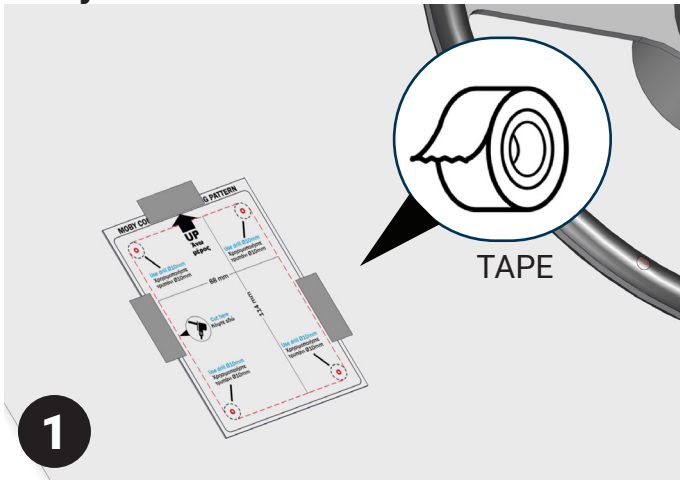

1. Place the Moby Drilling Pattern in the desired position, preferably a clean and easy-to-access area near the steering wheel of the boat.

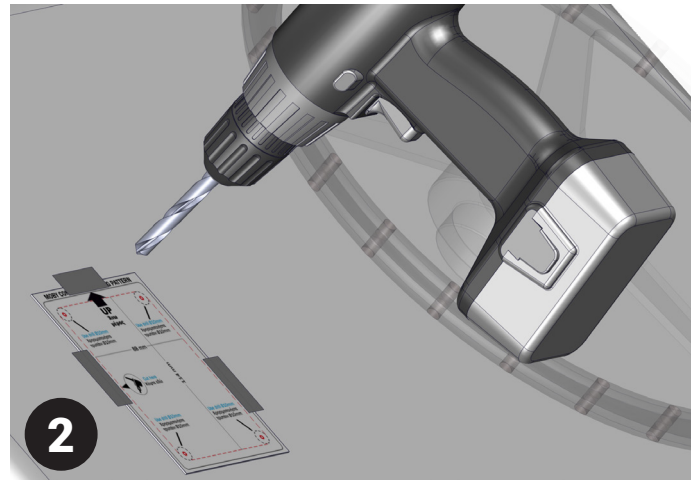

2. Drill the 4 holes according to the provided drilling pattern with 10mm bore.

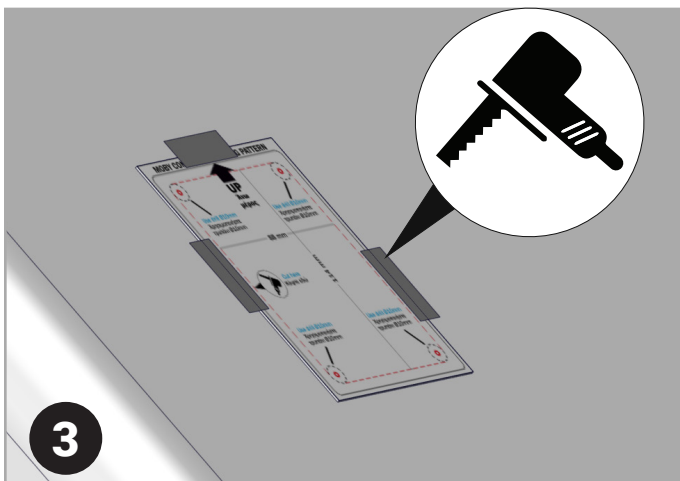

2. Create the central hole with an electric saw, following the cutting lines in the drilling pattern.

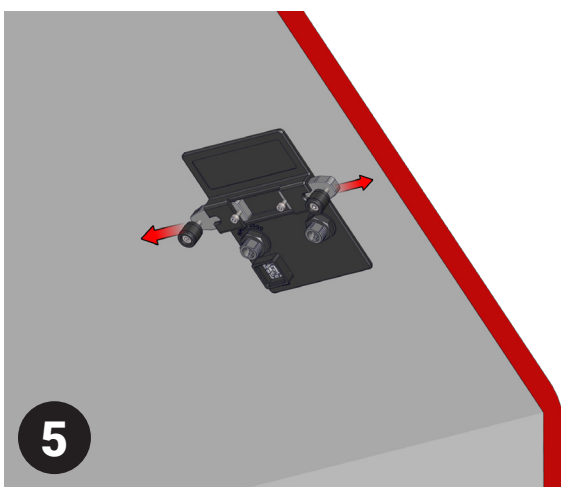
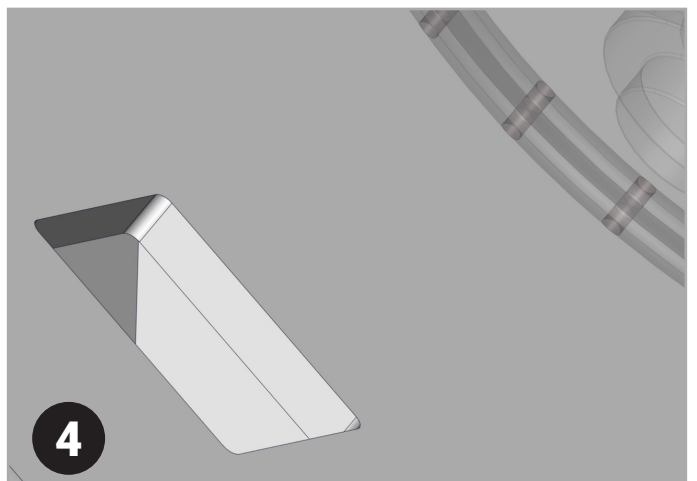

5. Place Moby Controller in its position, and mount it from the internal of the cockpit, with the given screws.

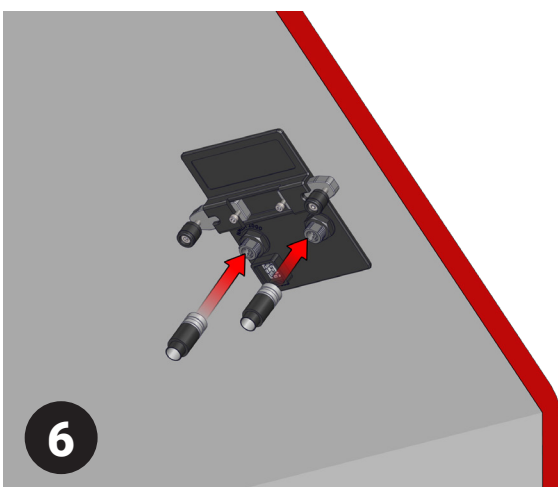

6. Mount the connection plugs in the 5-pole ports.

Initial Controller Activation

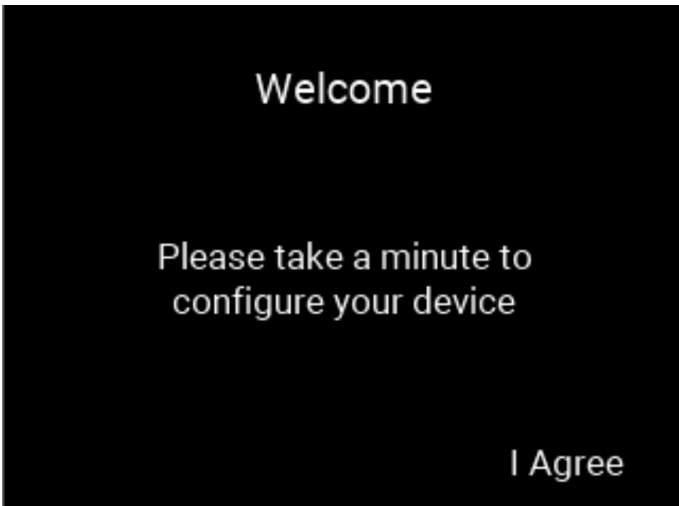

! Note: Slide joystick to  and hold for 8 seconds in order to switch on the device.



Initial Configuration.

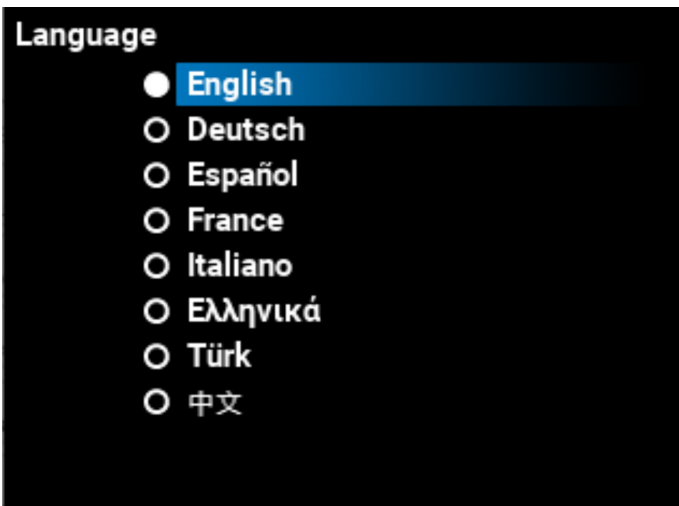

0.1 Welcome Screen: Slide  to proceed.





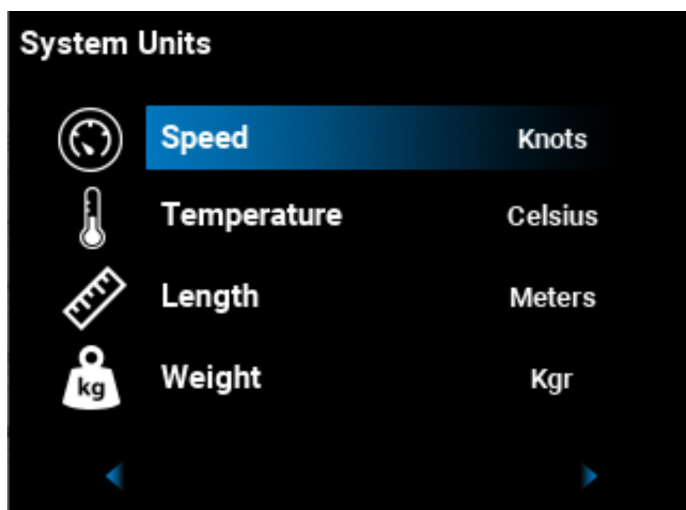

0.2 Language: Select from 8 different languages (EN, DE, ES, FR, IT, GR, TK, Simplified Chinese) by moving the joystick  and . Press  to proceed.

Moby Menu Screens Explanation

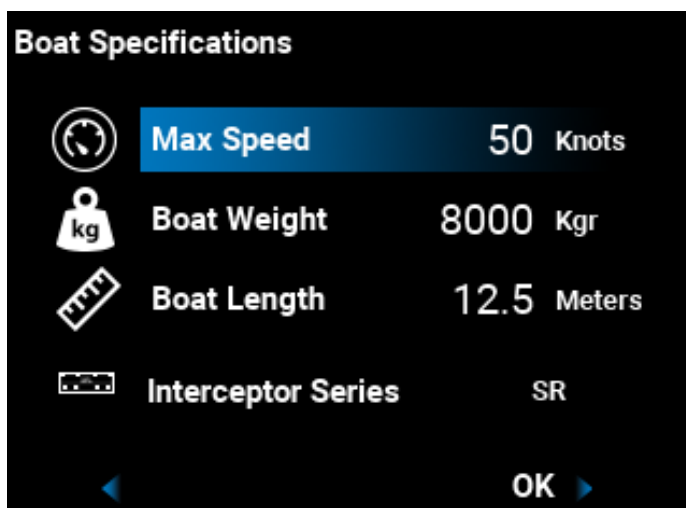

0.3 System Units: Set the desired units. Define the proper value by sliding , and confirm by sliding joystick .



0.4 Boat Specifications: Adjust the values by sliding the joystick  (decrease) and  (increase). The longer you press the joystick in a direction, the faster decreases or increases the value. Slide joystick  to confirm.



5.0 Warning Screen: Please pay attention to warning message. To proceed, confirm you agree by moving the joystick .

Moby Menu Screens Explanation

- 1. Auto:** Navigates you through the modes. Slide to navigate through different operation modes (Manual, Auto Pitch, Full Auto).
- 2. Menu:** Opens the menu (hold for 3 sec).

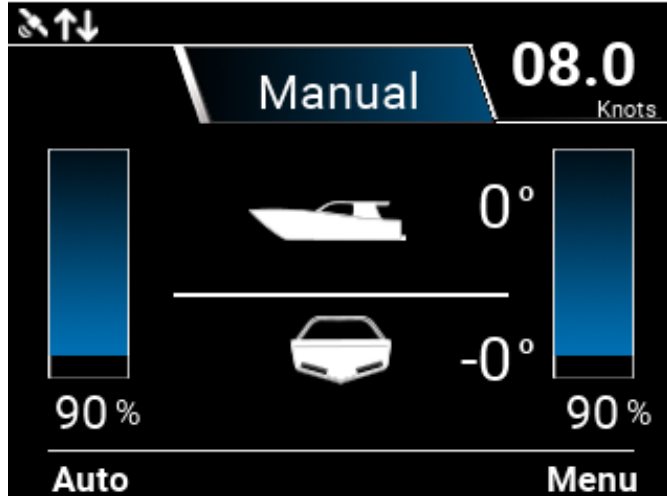

Operation Modes:

Manual:

Manual operation of interceptors.

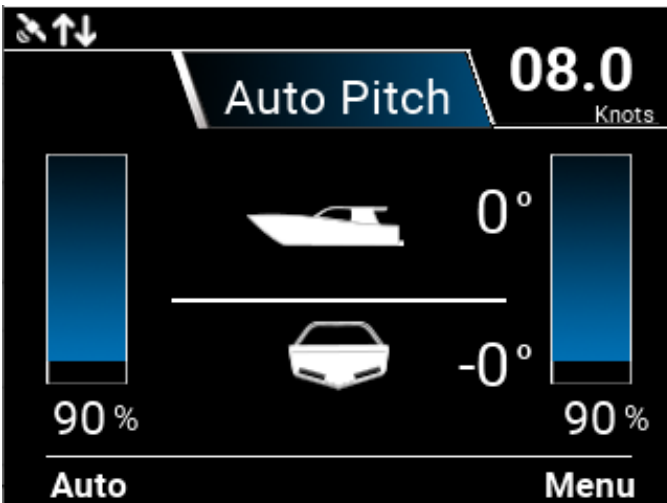
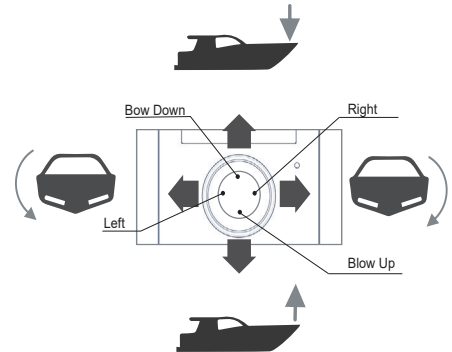

Auto Pitch:

Corrects angle according pitch profile (See paragraph 3.3.2).

Note: Auto modes (Auto Pitch, Full Auto, are available from speed above 7 knots.

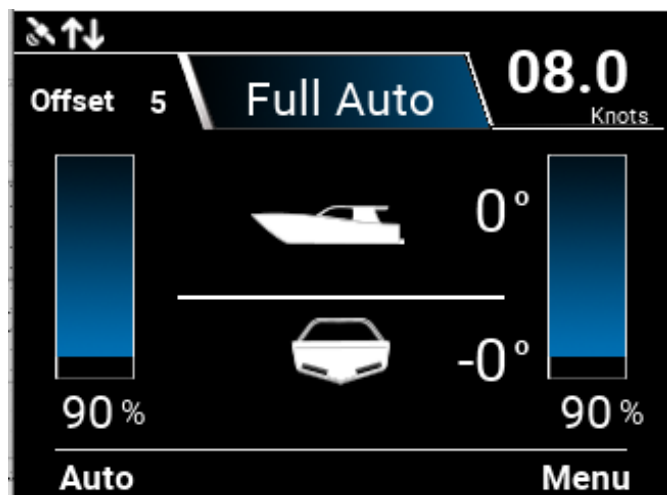

Full Auto:

Corrects pitch and roll at the same time. It follows pitch profile, and at the same time corrects side inclinations.

To adjust sensitivity, see paragraph 2.2.

In Full Auto Mode you can temporarily offset (increase or decrease) interceptors' deployment, by sliding the joystick or . The offset is displayed on top of interceptors gauges.

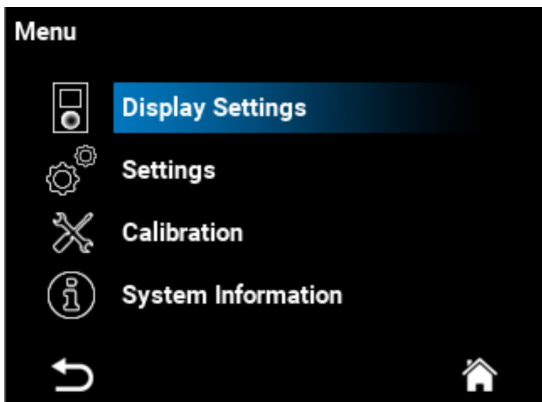

Attention! If you're going to need to maneuver sharply and/or urgently, auto roll mode must be disabled.

Moby Menu Screens Explanation- Display Settings





Menu Screen:

1. Display Settings
2. Settings
3. Calibration
4. System Information

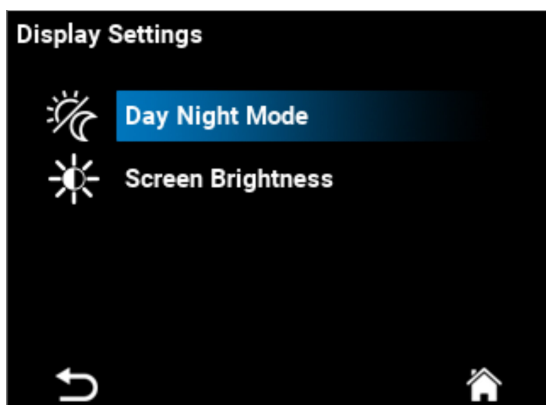
Slide joystick  or  to navigate and  to enter the submenus.



1. Display Settings:

- **Day Night Mode:** Automatic or manual selection of theme.
- **Screen Brightness:** Adjust screen brightness. Slide joystick  or  to navigate and  to go back.

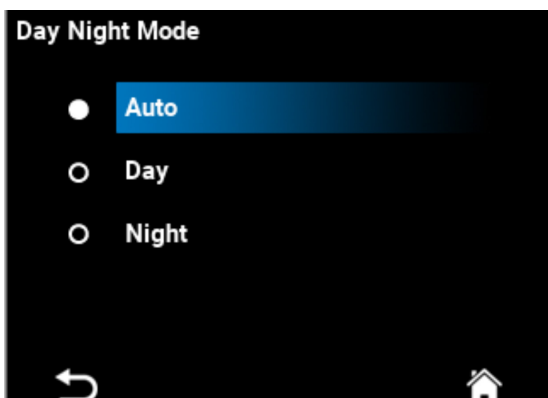

Day Night Mode



Auto: It Auto-switches the mode, with brightness change, according to the photosensor input.

Day: Bright theme for day usage

Night: Dark theme for night usage



Note: In Auto Mode, brightness cannot be changed manually.

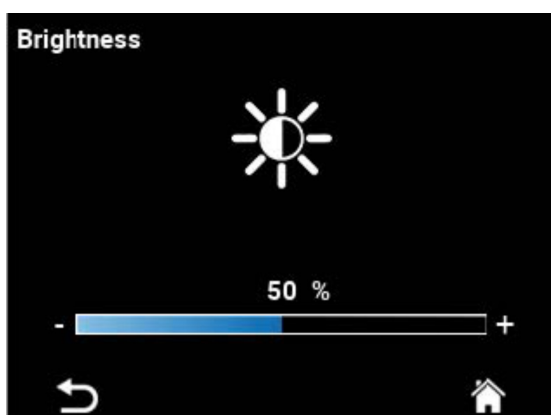

Note: In Day or Night mode, brightness can be changed manually.

You can navigate through options moving the joystick  or  and select with .



Screen brightness:

Adjust the screen brightness according to your preference, by sliding the joystick  or .

You can go back  or return to main screen by .

Moby Menu Screens Explanation- Settings

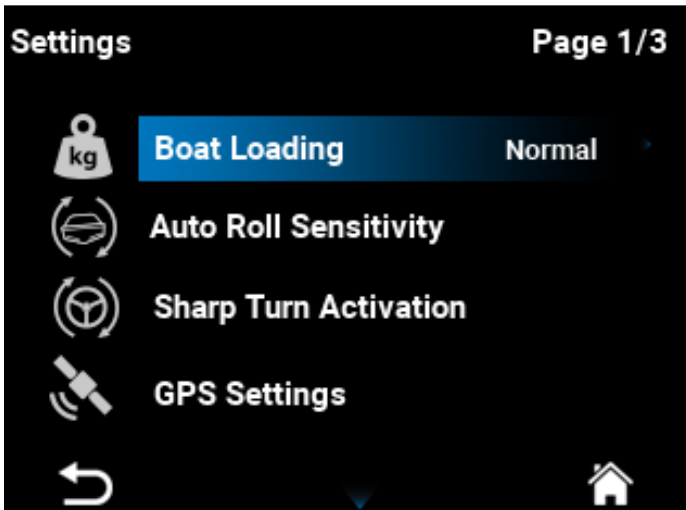

2. Settings:

Page 1/3 contains

2.1 Boat Loading:

2.2. Auto Roll Sensitivity

2.3 Sharp Turn Activation

2.4 GPS Settings



Settings (continued):

Page 2/3 contains:

2.5 Controller Type

2.6 System Units

2.7 Language

2.8 Reset to factory defaults

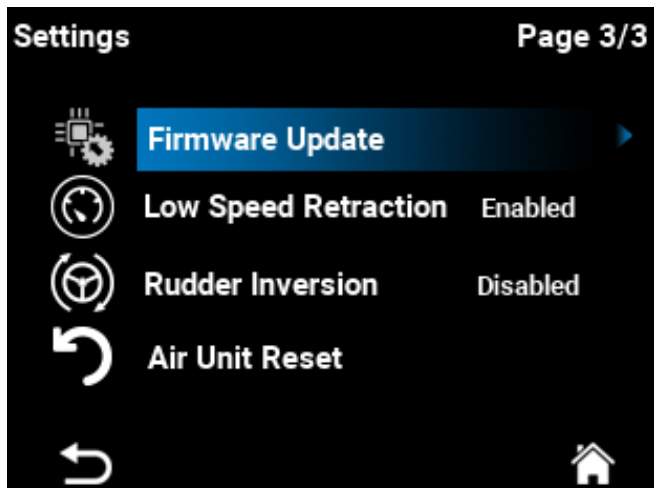

Settings (continued):

Page 3/3 contains:

2.9 Firmware Update

2.10 Low Speed Retraction

2.11 Rudder Inversion

2.12 Air Unit Reset

Moby Menu Screens Explanation- Settings

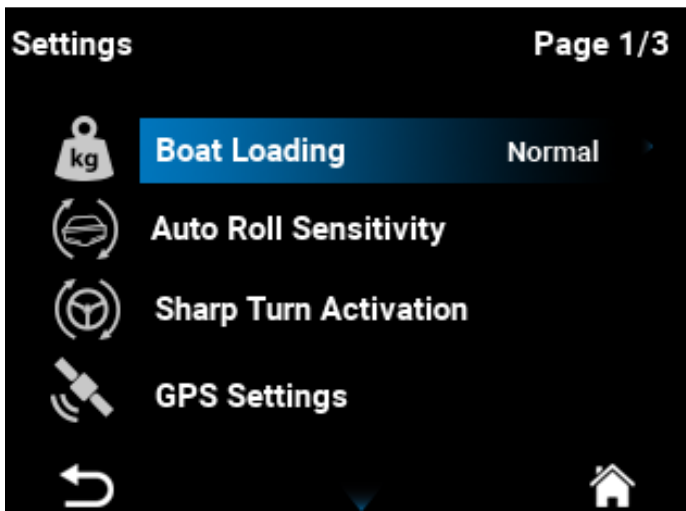

Boat Loading:

Select from Light, Normal and Heavy options.

- **Heavy:** when the boat is fully loaded.
- **Normal:** when standard loading has been made.
- **Light:** When load is below Normal weight.

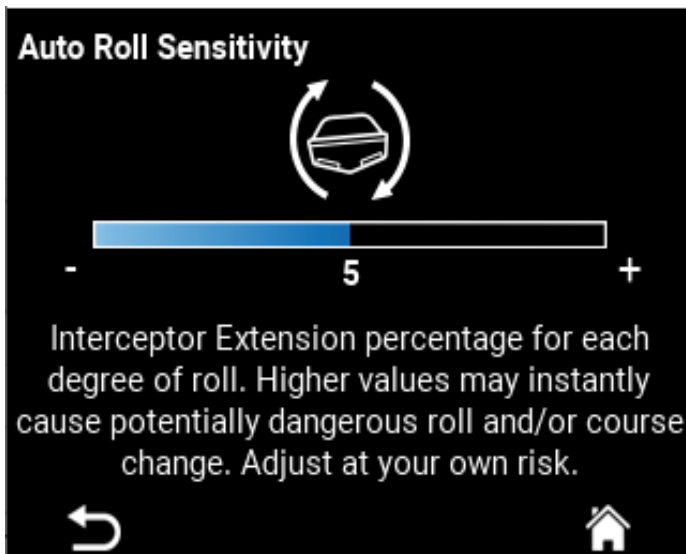

2.2 Auto Roll Sensitivity

Adjust the deployment percentage of interceptors for each degree of side inclination. The higher Sensitivity is, the higher deployment of interceptors is for every degree of side inclination. Attention: High Roll Sensitivity may abruptly affect course and stability of the boat, especially in higher speeds.

Note: If you set the sensitivity at max value, it may cause overheating of the Air Unit which will disable the Auto-Roll function until the system cooldown.

Adjust by moving the joystick ← or →. Go back by ↶ or return to main screen by ↷.

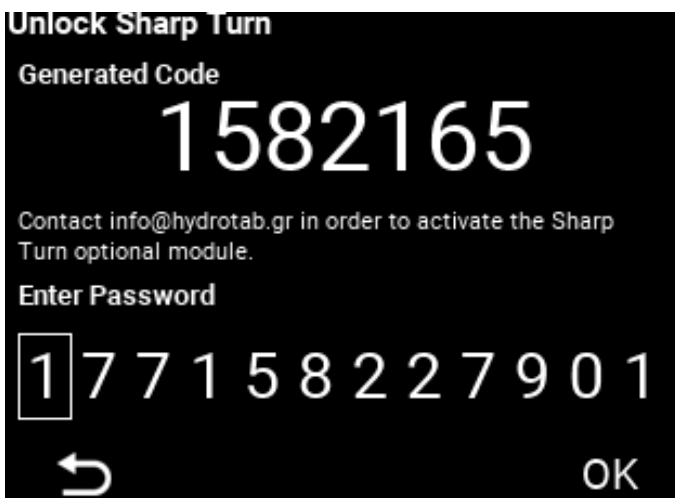

2.3 Sharp Turn Activation

On demand. Please contact us.

Moby Menu Screens Explanation-Settings

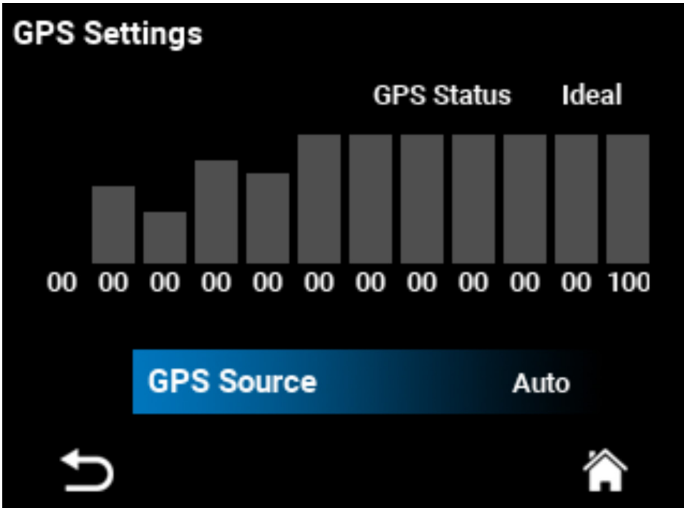

2.4 GPS Settings

GPS Status: Bars indicate satellite status.

GPS Source: Select GPS source for your interceptor system.

Auto: Moby determines and selects the source with the best reception.

Internal: Select this option in order to use the internal receiver with a passive (optional external) GPS antenna connected.

External: Select this option to use GPS data provided by an external GPS device through NMEA2k network.

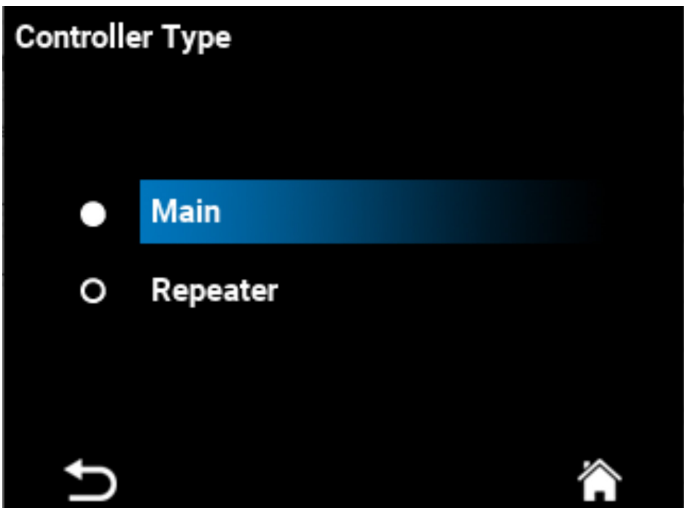

2.5 Controller Type:

Select:

Main: if the controller used is placed at the helm, or

Repeater: when the controller is placed at the flybridge station.

Attention! All system settings must be assigned **ONLY** from Main controller. You cannot use Repeater device in order to assign or change settings.



In case you change the Controller Type to Repeater Mode, you will lose all the stored settings.

Moby Menu Screens Explanation-Settings

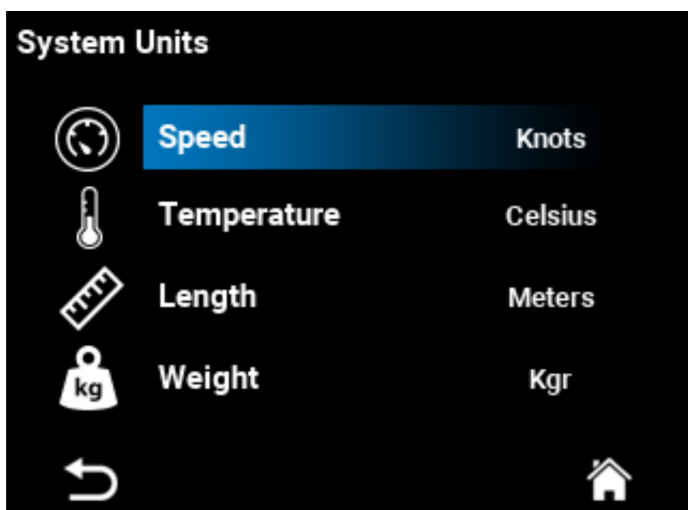

2.6 System Units:

Contains the following:

Speed: select between knots, mph, kmh.

Temperature: select between °F and °C.

Length: select between ft and meters.

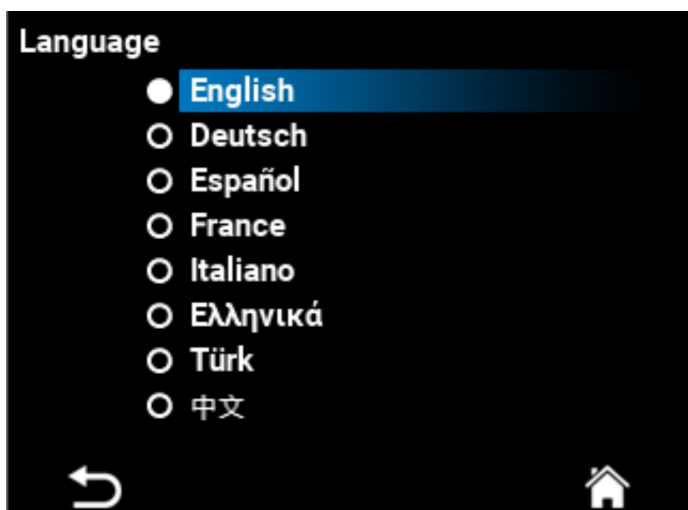

Weight: select between pounds and kgs.



2.7 Language:

Select from 8 different

languages (EN, DE, ES, FR, IT, EL, TR, 中文).

You can navigate by moving the joystick  or , and select with .



2.8 Reset to Factory Defaults:

 **Attention! Resetting will erase all your stored settings!**

Moby Menu Screens Explanation-Settings





2.9 Firmware Update:

You can initialize Firmware Update process.
(See paragraph 6.)

Attention: Do not activate Firmware Update without having the USB Memory Flash with the appropriate firmware already plugged in the USB Port.



2.9.1 If you want to start update process, agree by sliding joystick , or else go back , sliding .



2.9.2 Please follow the instructions. For more details, check the "Update Firmware" section in the manual.

You may proceed , or else go back .

Moby Menu Screens Explanation-Settings

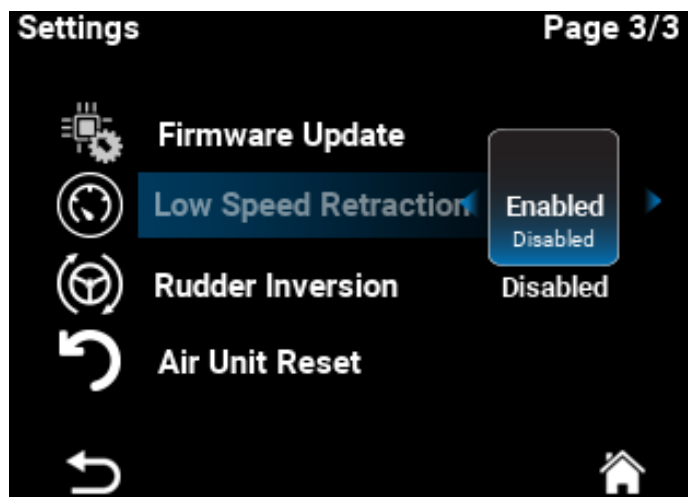

2.10 Low Speed Retraction

- **Enabled (default):** retract interceptors when speed is lower than 6 knots.
- **Disabled:** Interceptors are retracted manually.
Attention! Choosing disable the interceptors will remain extended and they can brake during haul out.

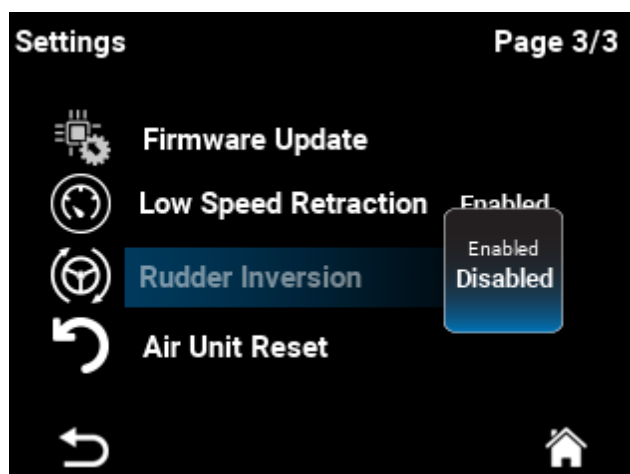

2.11 Rudder Inversion

Only to be used with sharp turn (optional function) .

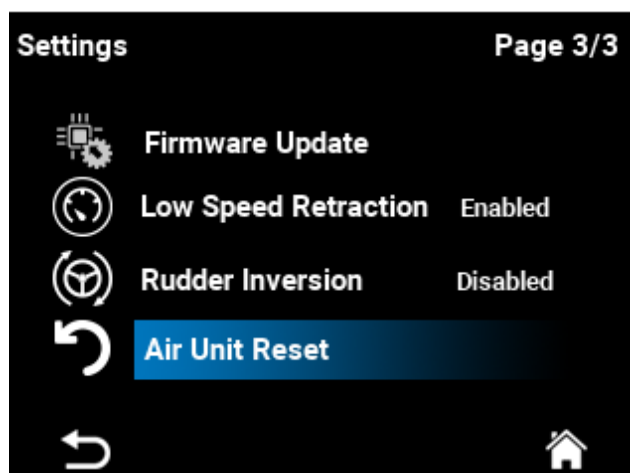

2.12 Air Unit Reset

Resets the air unit.

Moby Menu Screens Explanation-Calibration

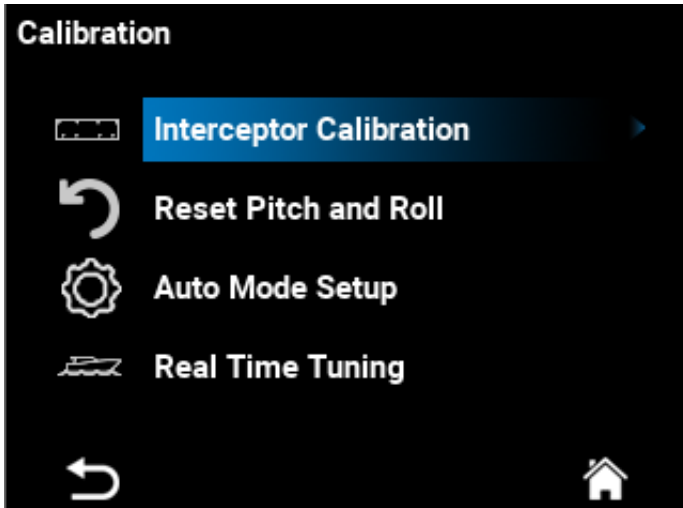

3. Calibration



Main Calibration Screen:

3.1 Interceptor Calibration

3.2 Reset Pitch and Roll

3.3 Auto Mode Setup

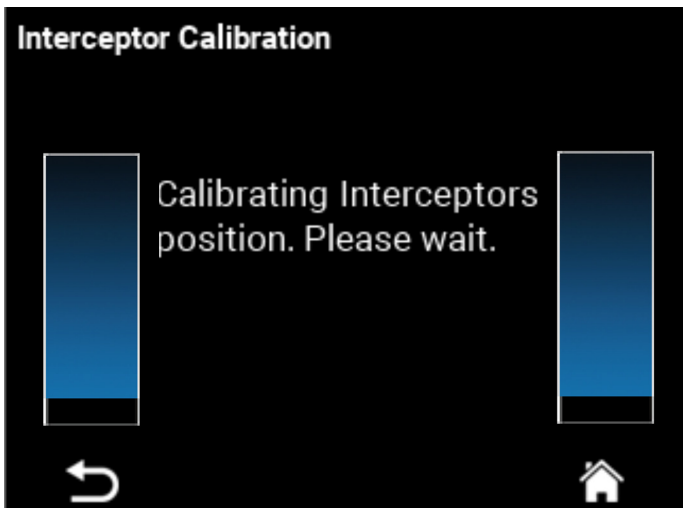

3.4 Real Time Tuning

Navigate by sliding joystick  or , and select with .



3.1 Interceptor Calibration:

Calibration starts automatically. A pop-up screen and notifies that calibration is completed. Move the joystick  to continue.

Go back by  or return to main screen by .

It counterbalances and calibrates air pressure of both interceptors. It should be executed after the initial installation, or after service jobs when any of the interceptors is disconnected from the air grid.

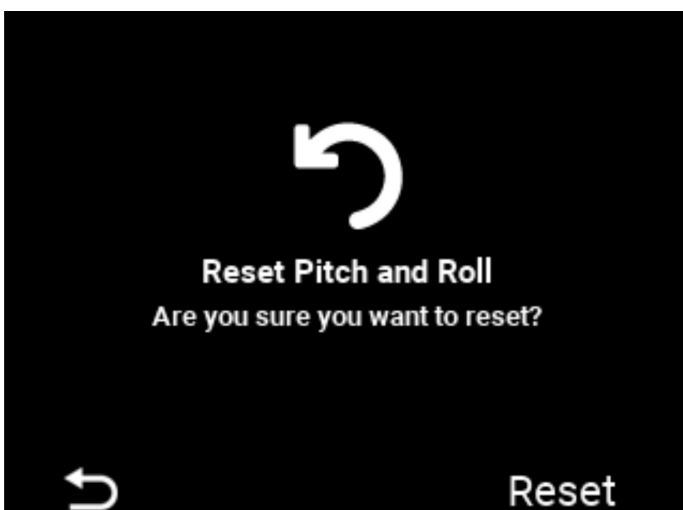

3.2 Reset Pitch and Roll:

“Reset” sets Roll value to zero according the desired boat position defined by the user. Reset must be done when the boat is in a calm sea and load is evenly distributed onboard, so the plane defined by waterline is parallel to sea plane. Pop-up screen shows when reset finishes.

Go back by  or select **Reset** by .

Moby Menu Screens Explanation-Calibration

! Useful Tip for Reset Pitch And Roll:

In case your boat is slightly unbalanced (due to uneven weight distribution), follow the procedure bellow for more accurate stability during **Full Auto Mode**.

In a calm sea go to Manual Mode, adjust your boat position in order to be aligned with the horizon and then press **Reset Pitch and Roll**. This procedure will make your interceptors to start extend in an uneven position, and will help to keep your boat better balanced during **Full Auto Mode**.

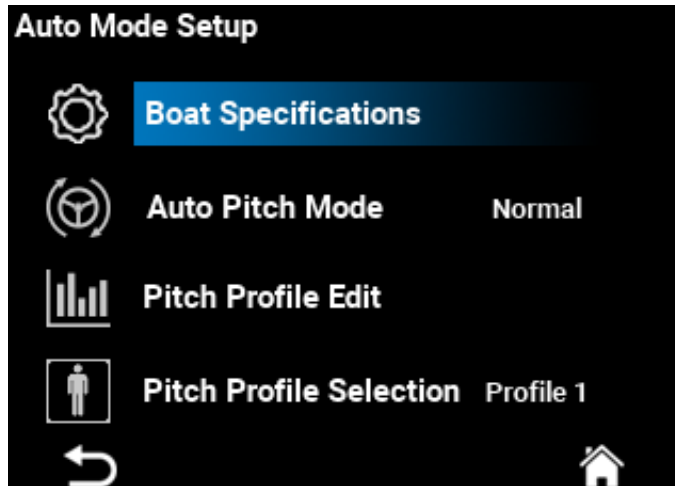

3.3 Auto Mode Setup:





3.3.1 Boat Specifications:

Import boat specifications (max speed, weight, length) or reset to defaults

3.3.2 Auto Pitch Mode



3.3.3 Pitch Profile Edit

3.3.4 Pitch Profile Selection

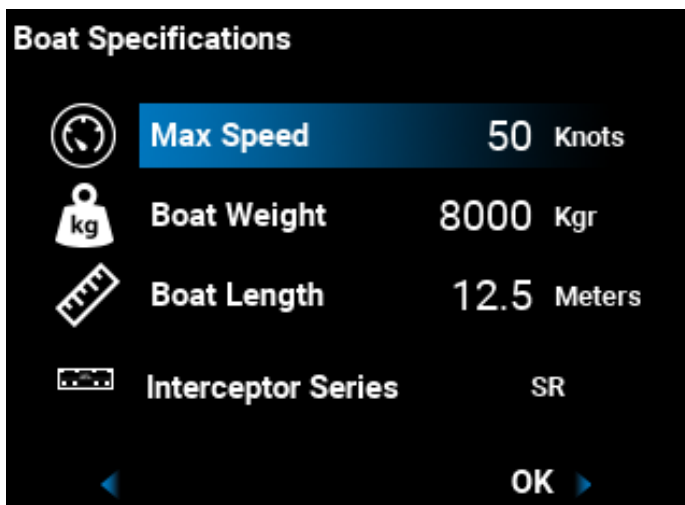
Navigate by moving the joystick  or  and select with . Go back by  or return to main screen by .



3.3.1 Boat Specifications:

Adjust the values by moving the joystick  (decrease) and  (increase). The longer you press the joystick in a direction, the faster decreases or increases the value.

Moby Menu Screens Explanation-Calibration

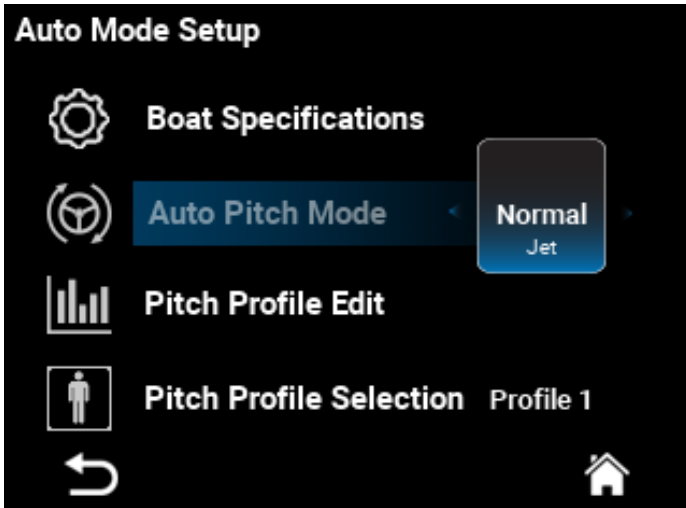

3.3.2 Auto Pitch Mode

Normal (Default): The interceptor will be auto adjusted according pitch profile.

Jet Mode: You can instantly affect the boat course by sliding joystick ← or → .

When not, the interceptors will return to the closest pitch profile stored value.

Ideal for test boats.

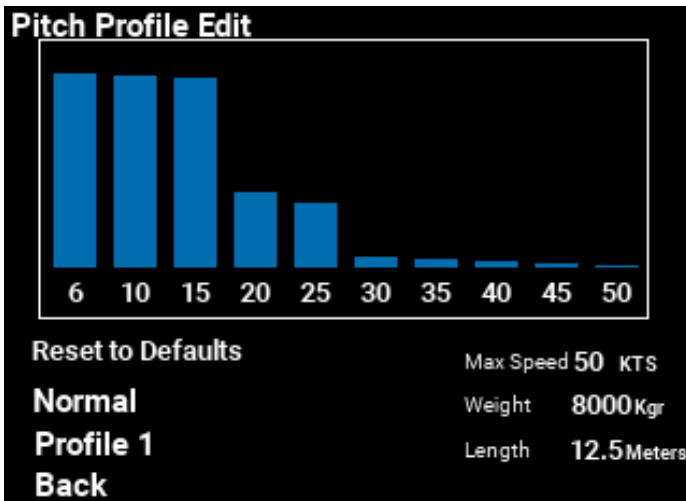

3.3.3 Pitch Profile Edit:

See page 19.

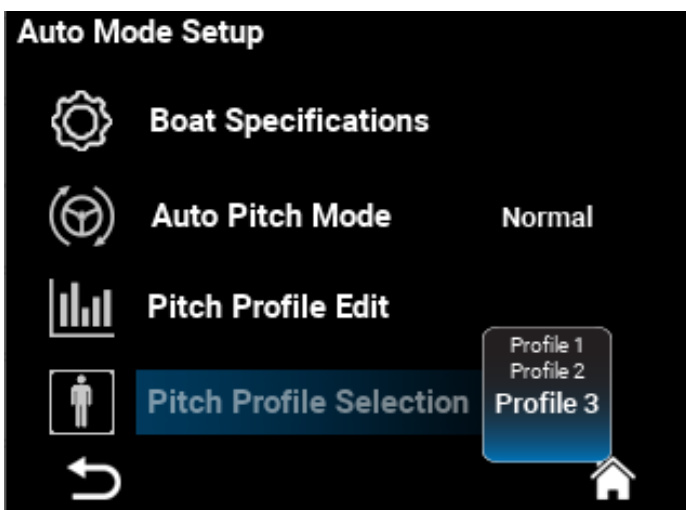

3.3.4 Pitch Profile Selection:

Select profile.

Moby Menu Screens Explanation - Pitch Profile Explanation

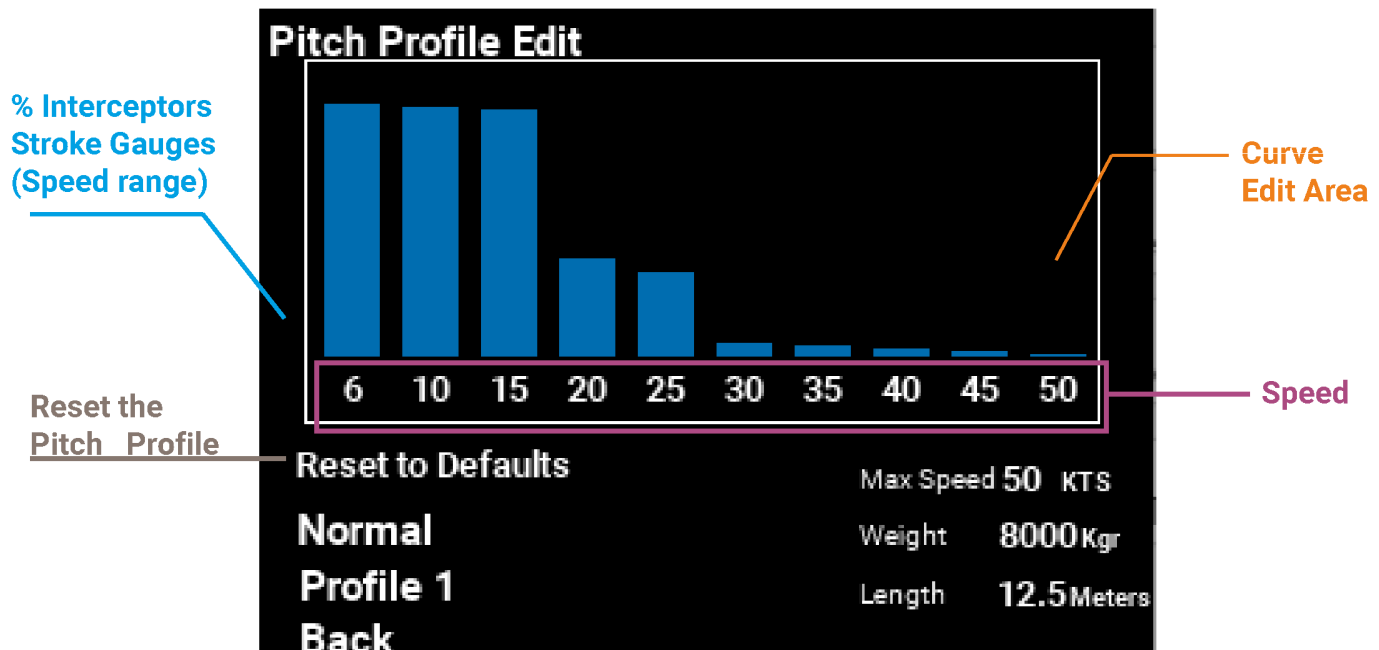

3.3.3. (continued): Each column in the **Curve Edit Area** shows the percentage of the **interceptor stroke** (deployment) according to different **speeds**. There are 10 segments of total speed range where you can set different amount of interceptors' deployment. Use **↔** to enter/leave the curve edit area.

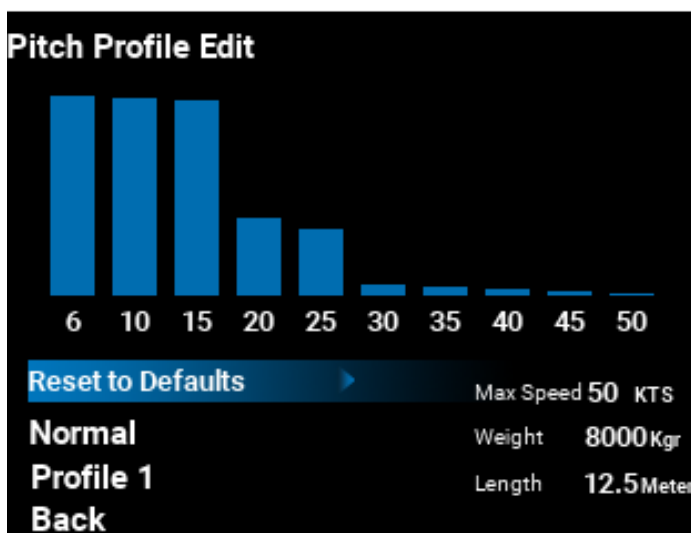

3.3.3 Reset Profile:

Reset to Defaults(for all Profiles): Initialize the values according to selected boat specifications

Save Temporary values: Store the temporary (offset) values as default values

Reset Offset: Delete the temporary (offset) values

Slide joystick **↔** to select and **↵** to confirm.

Heavy/Light/Normal:

Slide **↵** to select between three modes according to your boat loading.

Profile 1/Profile 2/ Profile 3: Choose the desired profile

Slide **↵** to select between three profiles

Back: Slide **↵** to go to Calibration menu.

Moby Menu Screens Explanation - Pitch Profile Explanation

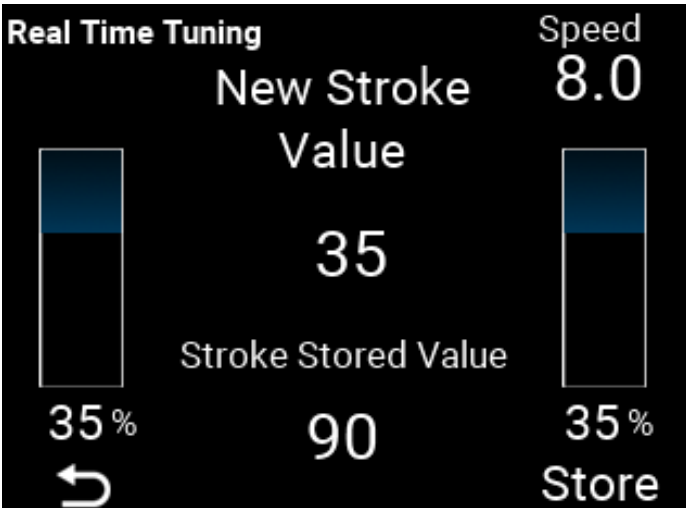

3.4 Real Time Tuning

Use realtime tuning to fine tune your pitch. During sea trial, you can choose this function which allows you to fine tune interceptors' position according different speeds in real time. The values you choose are stored in the nearest speed value of pitch profile curve.

Moby Menu Screens Explanation - System Information

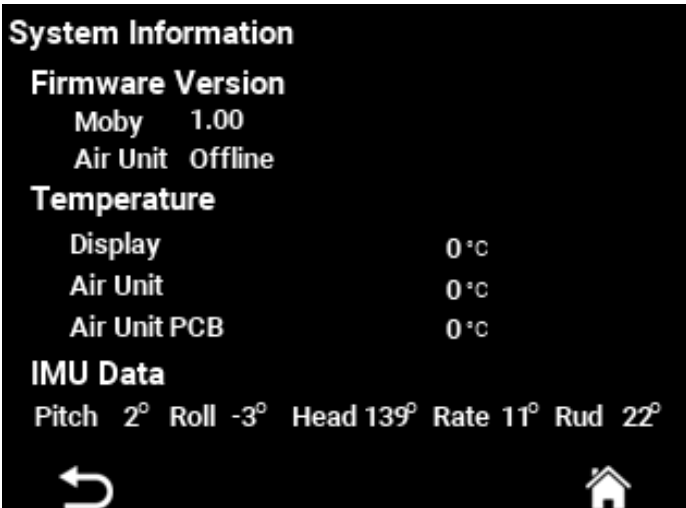

4. System Information

Shows useful information for Moby Controller and Air Unit.

Moby Menu Screens Explanation - Repeater Mode Screen Differentiation

! Notes: Your device can operate in two different modes, as Main device and as Repeater device. Main mode allows your full control of all the available operations of your controller. A Network in a boat can have many devices that communicate simultaneously, but only one of those can be a Main device. Repeater mode allows you to operate only the basic functions of your interceptors such as manual control of the interceptors and select between the operating modes of the controller.

If you wish to change the modes of your devices you first should change the one is on Main mode to Repeater, and then the rest. *Note that changing your controller type to Repeater will lead to lose of all your stored settings.

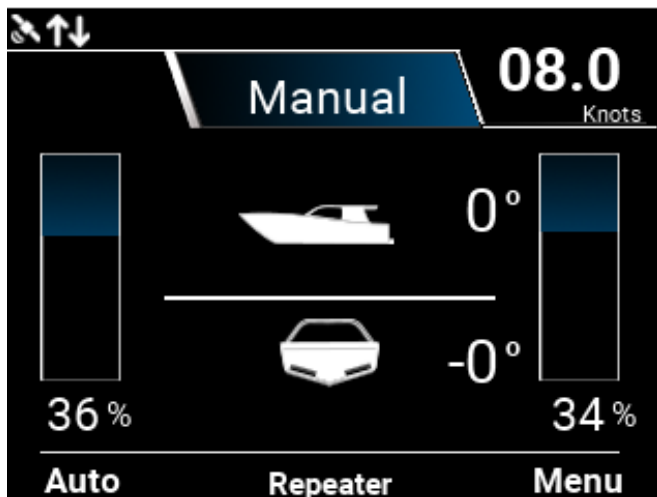

5.1 Repeater Main Screen

Repeater indication is located on the bottom of main screen.

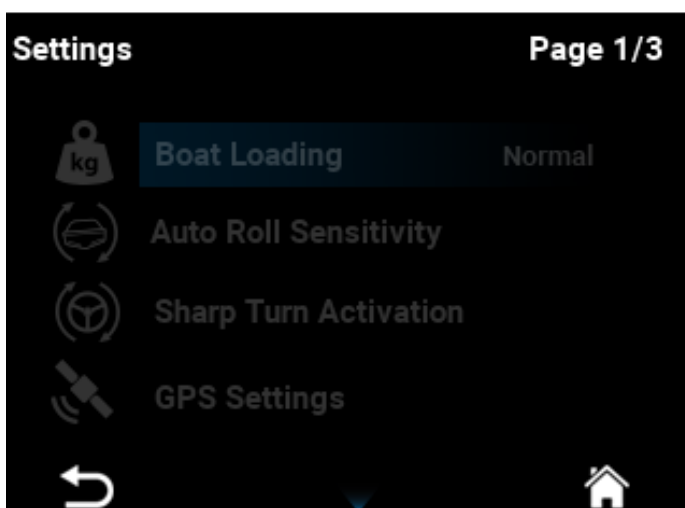

5.2 Repeater Settings (1/3) :

Settings are unavailable.

In order to change settings you must have access to main controller.

Moby Menu Screens Explanation - Repeater Mode Screen Differentiation

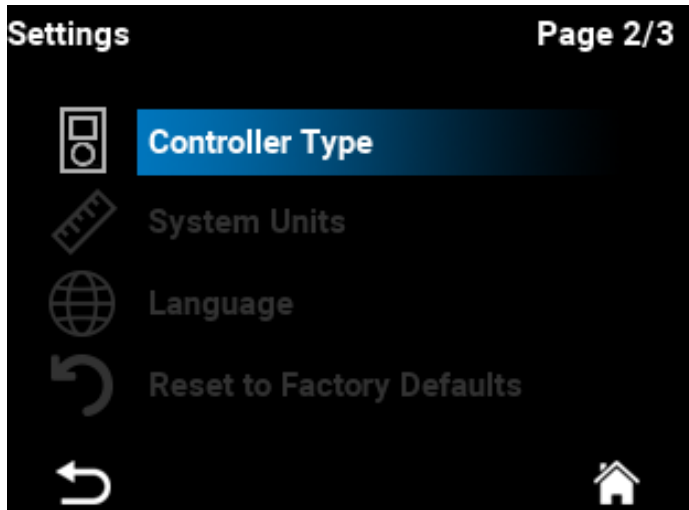

5.3 Repeater Settings (2/3):

The only available setting is the Controller Type (Main, Repeater). In case you need to switch modes of installed controllers, initially change Main to Repeater and then Repeater to Main.

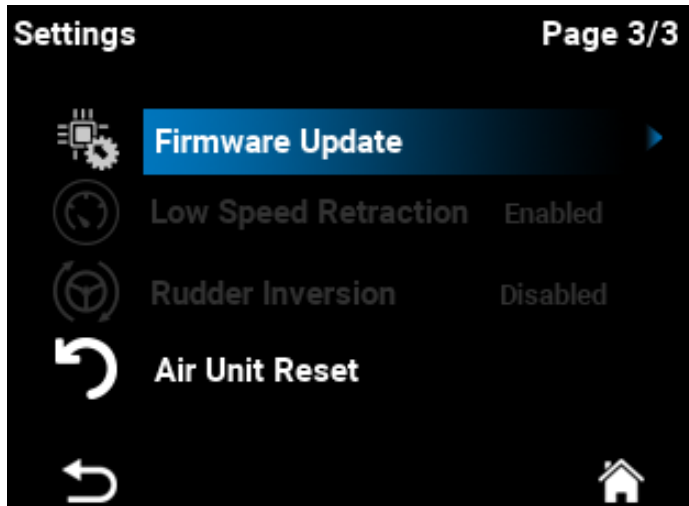

5.4 Repeater Settings (3/3):

Slide → to update firmware. See paragraph 6.

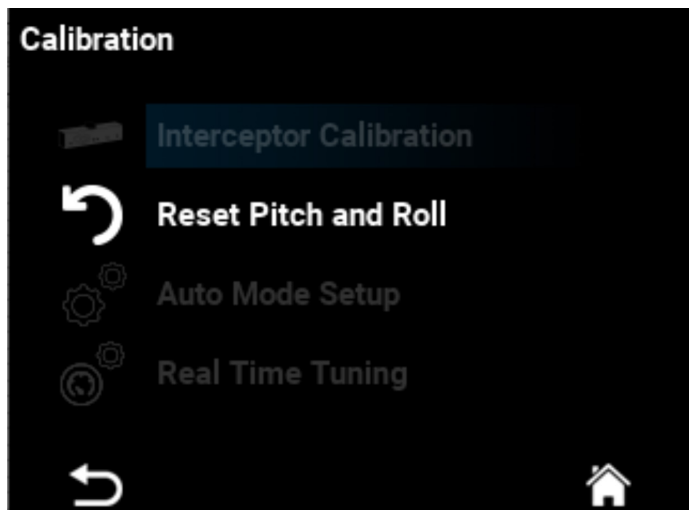

5.5 Reset Repeater's Pitch and Roll:

Press "Reset" to reset Pitch+Roll. It adjusts the gyroscope angles according to the controller's placement in the boat's panel. Reset must be done when the boat is in a calm sea and load is distributed onboard, so the plane defined by waterline is parallel to sea plane. Pop-up screen shows when reset finishes.

Go back by sliding ← or select Reset by →.

Moby Menu Screens Explanation - Updating your Device Firmware

Before you start the update, you will need:

- Latest firmware. You can find and download the latest firmware here : <https://www.hydrotab.gr/downloads/>
- A USB drive. We recommend formatting the USB drive before installing the new drivers.
- The provided adapter USB a female to USB b male

Before you start the update, make sure:

- Do not disconnect power during installation.
- The USB drive has the correct version and is the only file installed.
- Do not disconnect the USB drive during update.
- In case of Main and Repaired Controller, both need to be updated separately.

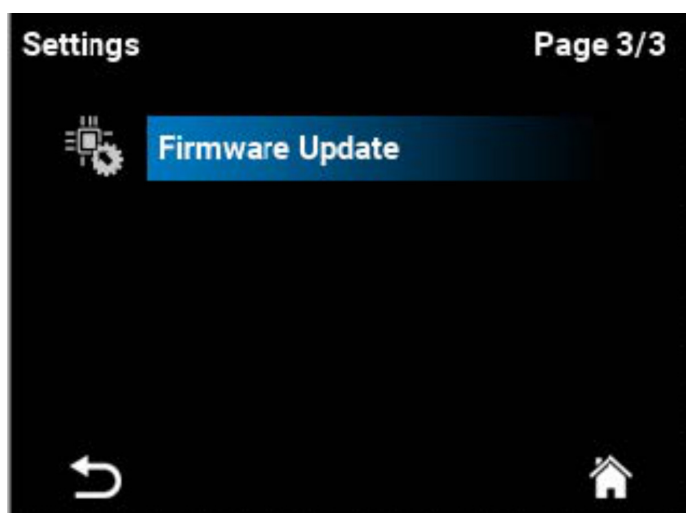

6.1.1 Firmware Update:

Go to the 3rd page of settings, and choose Firmware Update .



6.1.2

You may proceed , or else go back .

Moby Menu Screens Explanation - Updating your Device Firmware

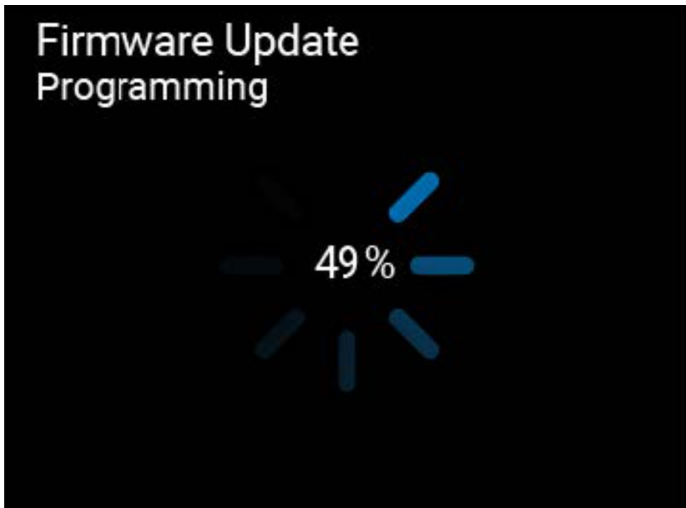

6.2.1 Wait until update is completed.

! Note:

- If the message "Verify Error" appears, that means something went wrong. You must restart your controller by unplug and plug the power again, and then redo the whole process.
- If the message "Flash Config Error" or "Disk Error" appears, use a different USB drive.

After the end of Update your device will restart and the new Firmware Installed.

! Note:

- If the message "File Not Found" appears, that means the USB drive is empty. Make sure you have installed an appropriate file.
- If the message "Wrong File Format" appears, that means the file is not correct, corrupted or not properly installed. Please format again the USB drive, download the drivers again and install them again. Make sure not to remove the USB drive before the process is complete.

Moby Troubleshooting

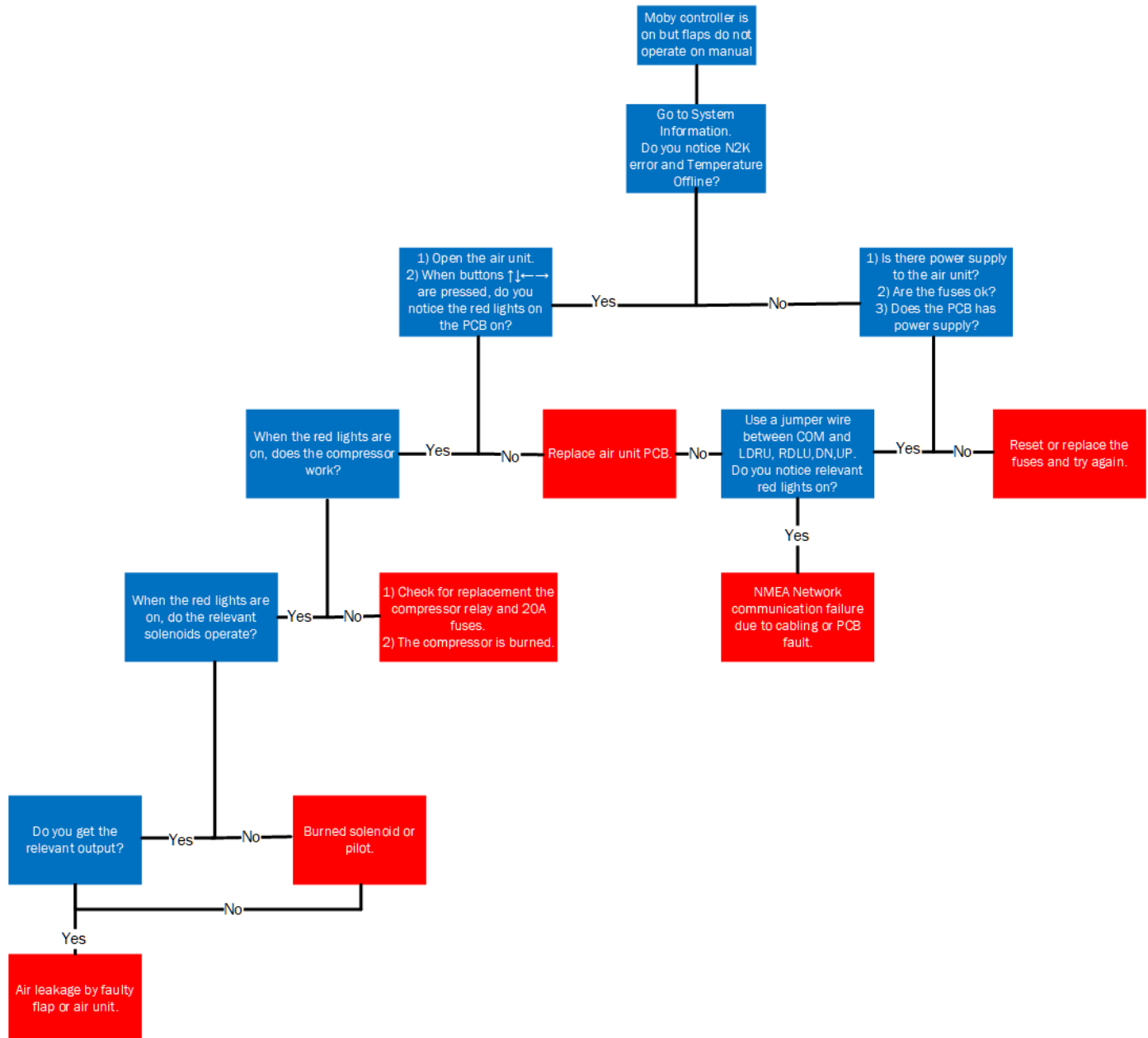

Notes

A large grid of graph paper for taking notes, consisting of 20 columns and 30 rows of small squares.

Notes

A large grid of graph paper, consisting of 20 columns and 30 rows of small squares, intended for taking notes.